

## STAINLESS STEEL TOUCH CONTROL FOR STP and STN STEAM GENERATORS



Congratulations on your purchase of Stainless Steel Touch Control Unit!  
Please read the manual carefully before using the steam generator.

Not for use in the USA, Canada and Mexico.

ENGLISH

# TABLE OF CONTENTS

<b>INTRODUCTION</b> .....	3
<b>INSTALLING THE CONTROL UNIT</b> .....	4
<b>OFF MODE</b> .....	5
ON/OFF Button .....	5
Current day & Time Button .....	5
Light Button .....	5
Hidden Button .....	5
Settings Menu and Keylock .....	6
Day and Time .....	6
Kilowatt Value .....	6
Counters .....	6
Autodrain .....	7
Decalcifying .....	7
Blackout Memory .....	7
Temperature Scale .....	7
Standby Temperature Settings .....	7
Auto Set Light .....	7
Auto Set Fan .....	8
Software Version .....	8
LCD Contrast Setting .....	8
Factory Reset .....	8
Save and EXIT .....	8
Preset time settings .....	9
Preset Time .....	9
<b>ON MODE</b> .....	10
Steam ON .....	10
Day and Session Time .....	10
Temperature Setup .....	10
Optional features .....	11
Aroma .....	11
Dimmer .....	11
Fan .....	11
<b>STANDBY MODE</b> .....	12
Current Day and Standby Time .....	12
Pause Button .....	12
<b>DRAIN MODE</b> .....	12
<b>EASY MODE</b> .....	13
Hidden Button .....	13
Steam ON .....	13
<b>STEAM GENERATOR DIP SWITCHES</b> .....	14
Standby Time .....	14
Session Time .....	14
First Block of 8 Switches .....	14
DIP Switches for Naming Slaves .....	14
SIP Switches for Other Functions .....	14
<b>CONTROL PANEL DIP SWITCHES</b> .....	15
<b>REMOTE AND ALARM CONNECTIONS</b> .....	16
Emergency Alarm .....	16
Remote On .....	16
<b>MAINTENANCE</b> .....	17
Decalcification .....	17
<b>TROUBLESHOOTING</b> .....	18
For tandem connection: .....	18
Error codes: .....	18



READ THE MANUAL FOR  
ADDITIONAL IMPORTANT  
INSTRUCTIONS



COVERING THE HEATER  
CAUSES FIRE HAZARD

# INTRODUCTION

There are five different operation modes in the unit: OFF, ON, Standby, Easy Mode and Drain. The user can easily switch between different modes making the steam bathing more convenient.

To use the steam room, the control unit needs to be in ON Mode. In the ON mode, the steam generator is producing steam and temperature in the steam room is kept in preferred set temperature with occasional discharge of steam.

However, if the steam room is not used constantly, the generator can be set to Standby Mode. During the Standby Mode, water and steam room are kept warm with minimal energy consumption. The generator is able to produce steam shortly after the unit is switched back to ON mode for the user's convenience.

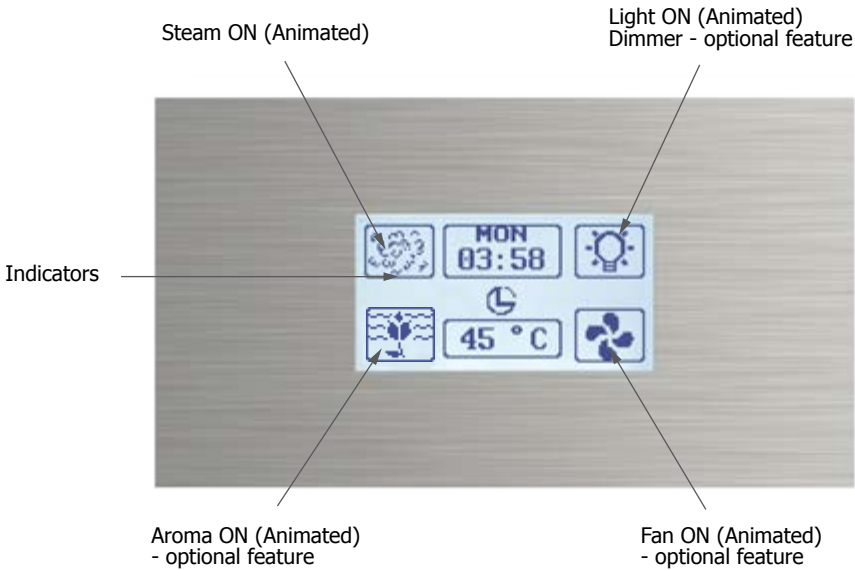

## INDICATORS



Keylock is on.



Preset time is activated. See page 9.



Heating element error icon shows if there is a problem with the heating elements. Refer to Factory Reset, See page 8.

# INSTALLING THE CONTROL UNIT

Check the most suitable area to place your steam generator control. The control and the steam generator should be accessible for the user and for maintenance. Do not install the control unit inside the steam room! The cable connecting the control unit and the steam generator is 7.5 meters long.

Never attempt to modify or fix the steam control. Contact your licensed technician or your nearest service center for repair.

Before installation, main power supply of the generator must be switch off from the circuit breaker.

Mount the control unit in the wall according to the specifications given below. Follow the illustrations.

## NOTE!

Run the Factory Reset after installing the steam generator for the first time or after changing the control panel. See page 8.

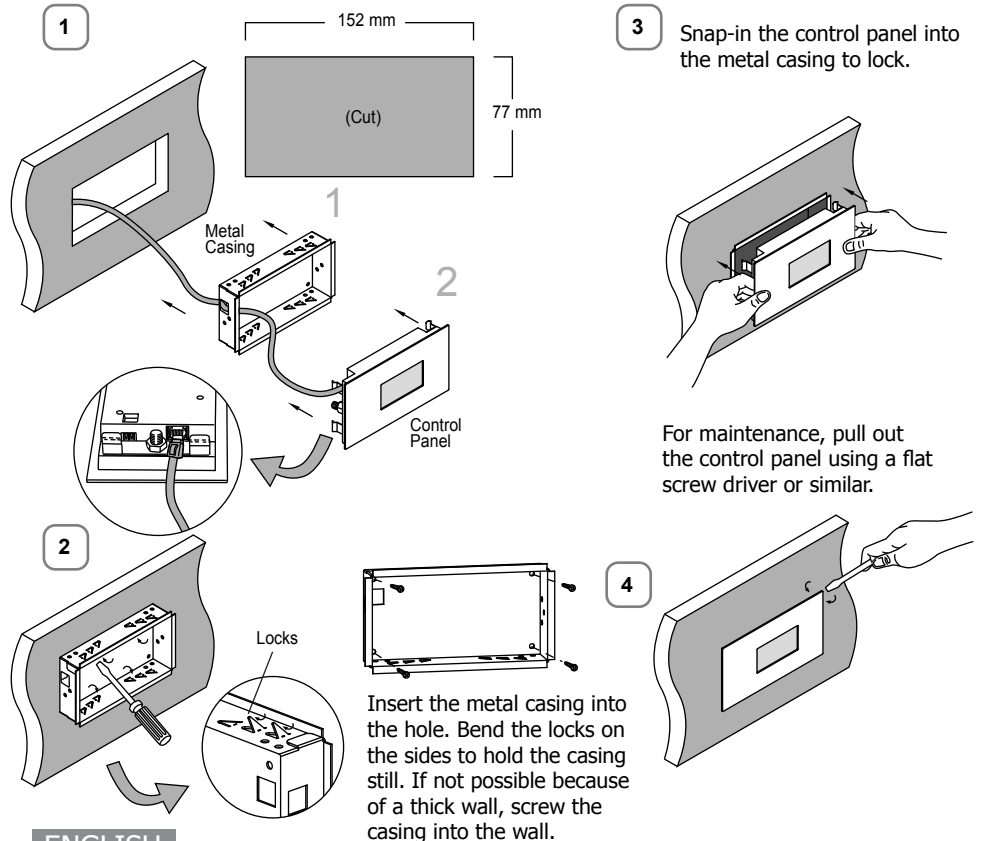

# OFF MODE

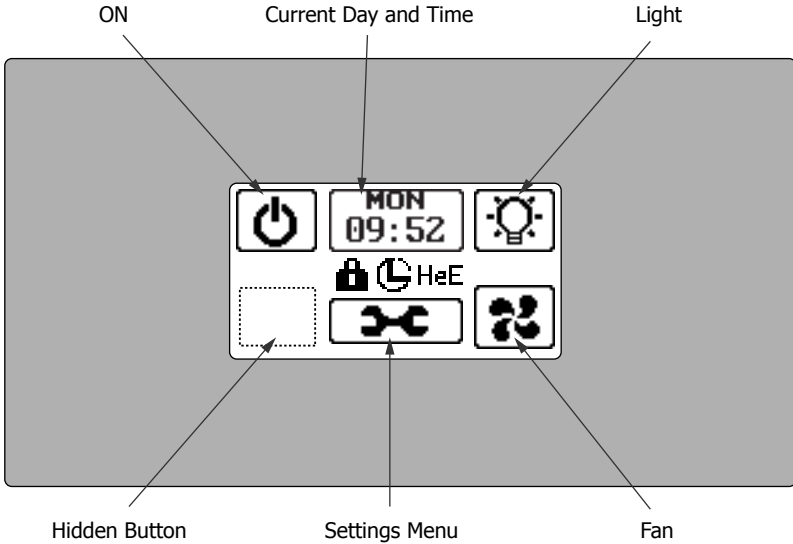

## ON/OFF Button



Pressing shortly the ON button will switch the steam generator ON. Temperature and session-time setting is automatically set based on the saved settings from the previous session. To change the settings, press the Settings Menu.

Switch OFF the display by pressing for the ON/OFF button 3 seconds. Tap the display to turn it on.

---

## Current day & Time Button



Day and Clock button is displayed in the OFF Mode. It shows the current day and time.

Long press the button to jump into Pre-Set Time setup. See page 9, Pre-set time setting.

---

## Light Button



Toggle the light button to switch ON/OFF your steam room lights.

When your steam generator has a dimmer feature you can adjust the brightness from 0-100%. Dimmer setting appears when you turn on the light or long press the light button while light is on.

---

## Hidden Button



The hidden button is the gateway to Easy Mode. Long press 10 seconds to activate the Easy Mode.

## Settings Menu and Keylock

### The Settings Menu is only available in the OFF State.



Press not less than 5 seconds and release the button to enter setup. A beeping sound will signal the change of menu status. Here you may preset session time, temperature, fan, light, perform steam generator maintenance and access to useful information about your steam control system.



To lock/unlock screen, press more than 10 seconds the Settings Menu button. Lock icon will appear on the display.

### Day and Time



Select the day and time by pressing the day, hour and minute button. Change values by short or long pressing the buttons. Long pressing hour or minute button will change numbers faster.

### Kilowatt Value



Set the correct kilowatt value of the steam generator to the control (see kilowatt information on your steam generator). Press the arrow up or down to select.

### Counters



Counters display the usage of time and kilowatt of the steam generator. This information is very necessary to evaluate the need of a preventive maintenance and compute electricity consumption.



Pressing the Reset button will reset the ON hours and kWh counters. Previous data cannot be retrieved after resetting the counter.

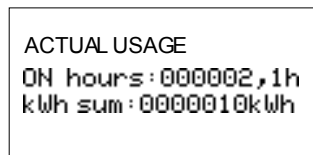

Press reset button for 10 seconds to display the actual usage information. This usage counter cannot be erased. It shows usage of the control panel since the manufacturing date.

## Autodrain

Bold outline means selected.



The autodrain is set to ON by default. For manual drain, select OFF to deactivate the function.

When autodrain is ON, it will automatically drain the water inside the steam generator tank after use. In case of power interruption, it will continue to drain when detecting a high water level in the tank.

---

## Decalcifying



Decalcifying function is very useful for maintenance. This function requires autodrain.

Read more information on how to decalcify your steam generator tank. See page 17.

---

## Blackout Memory

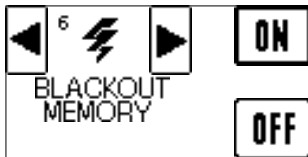

Active Blackout Memory restores control to its previous state before power failure. For example, if steam generator was on before power failure, the steam generator will automatically continue from the previous state.

---

## Temperature Scale



You may set the temperature scale either Celsius or Fahrenheit.

---

## Standby Temperature Settings



Steam room temperature will be maintained during Standby Mode. Standby temperature can be set from 00C to 450C.

---

## Auto Set Light



The light can be set as auto ON or OFF. When the light is set to auto ON the light will switch ON when the steam generator is in ON or Standby mode.

## Auto Set Fan

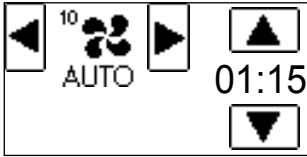

Auto fan turns on the fan once control goes to Off Mode to dry out the steam room. Fan will remain on for selected time. You may adjust the time from 0 - 24 hours with 15minute intervals. Auto fan is activated only when the animated Auto button is displayed on the screen.

---

## Software Version



Software version has two parts, Interface Software Version and the Controller Board Version.

---

## LCD Contrast Setting



You can adjust the contrast of the display between 0 and 100.

---

## Factory Reset



Press the HeE RESET to remove heating element error after checking or fixing the heating elements. If steam generator's kW is changed, press reset button instead.

Pressing the RESET button will revert all settings to factory default. This is used when there is a malfunction on the machine or you wish to clear previous settings. Factory reset does not reset on hours and kWh counters.

---

## Save and EXIT

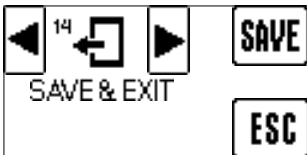

Once everything has been set, you may press SAVE to save all the setup or ESC if you wish to abort the settings.



# PRESET TIME SETTINGS

## Current Day and Time

Long press to activate the Preset Settings

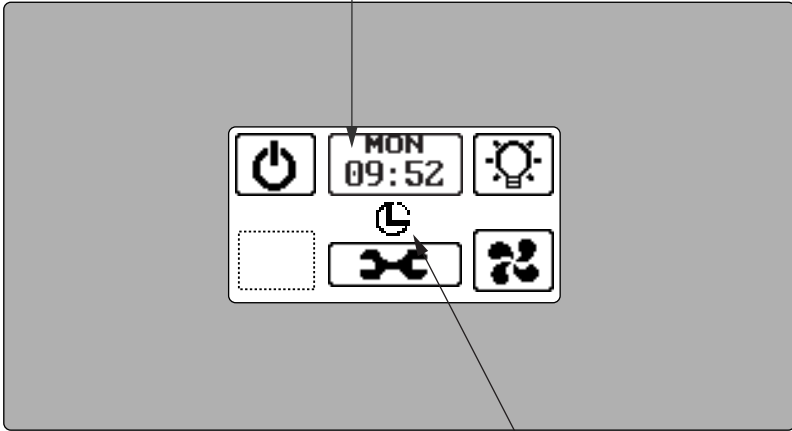

Preset activated

## Preset Time



This can be switched OFF/ON. A small icon appears on the screen indicating that the Preset Time is activated.

Press ON to set preset time. When presetting time, you can set the day and time for your steam session.



Darkened area is the active area that can be modified. Press arrows left or right to change settings. Tap the active area to jump into next setting. When start time and end time are same, there is no steam session. Maximum session time depends on the dip switch setting on the steam generator. (See Steam Generator DIP switches at page 14).

Three-arrow button copies settings from the day on the left to the day on the right. Press OK when all is set.

# ON MODE

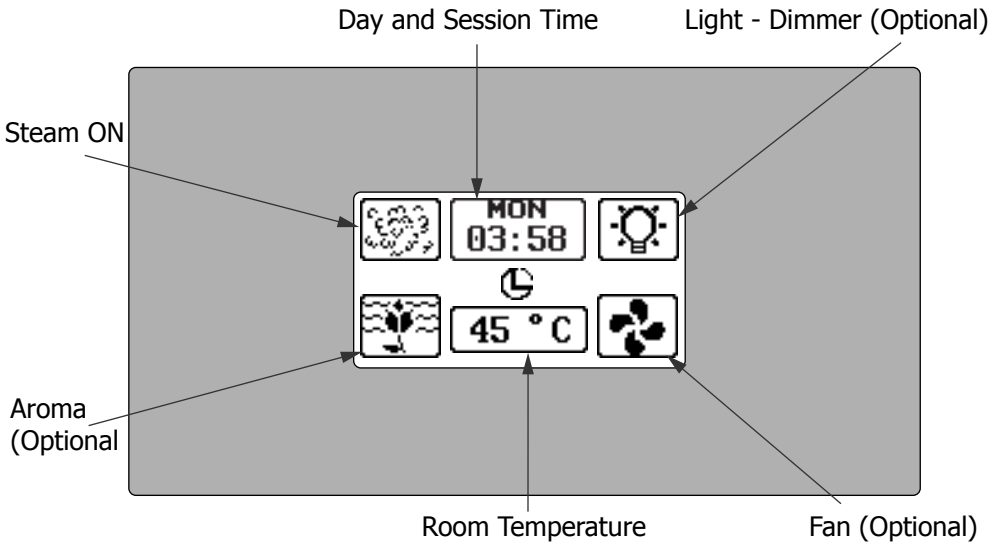

## Steam ON



The steam generator produces steam during ON mode. In this mode, you will find the steam button animated, indicating that the steam session is ongoing.

Short press the Steam ON button to switch on Standby Mode. Long press the steam button to switch OFF. If autodrain is present, steam generator goes to Drain Mode and turns off after draining.

---

## Day and Session Time

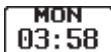

The day indicates current day which can be set in the Day and Time setup in Settings Menu.

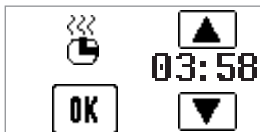

Session time is the remaining time of using the steam room. The session time can be set until 24hours and it counts down. When Day and Session button is pressed, a setup screen will appear. Use arrows up and down to change the session time and hit OK when values are set.

Maximum length of the session time can be set on the DIP switches. (See Steam Generator DIP switches on page 14).

---

## Temperature Setup

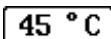

The temperature button indicates either the actual or target steam room temperature (refer to Control Panel DIP switches see page 15). Press the up and down arrow keys to change the temperature settings inside the steam room.

## OPTIONAL FEATURES

Check your steam generator if these features are included.

### Aroma



This icon appears when aroma feature is present and only in the On Mode.

Short press this animated button to switch on or off the aroma pump. Long press the button to adjust the settings.

Aroma can be set from 0-20. Hold-press set to 20 for a full aroma pump, otherwise when released, it goes down to 19. This function operates only in ON mode.

In case if aroma setting is switched off or the Session Time expires, on the next steam session, previous settings apply.

---

### Dimmer



When your steam generator has a dimmer feature you can adjust the light brightness from 0-100%. Dimmer setting appears when you turn on the light or long press the light button while light is on.

---

### Fan



Short press the fan button to turn fan on or off. Animated button means fan is switched on.

Auto fan turns on the fan once control goes to Off Mode. Fan will remain on for selected time. Refer to Autofan settings point on page 8.

# STANDBY MODE

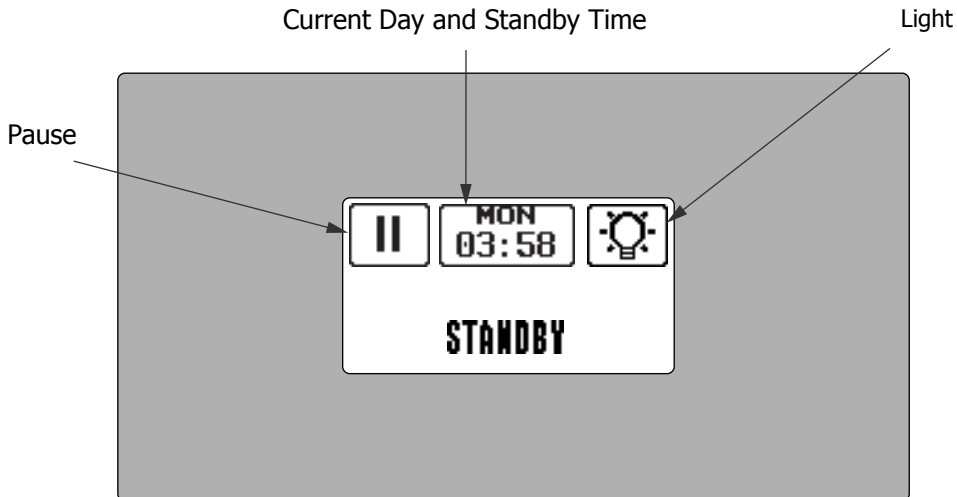

Standby Mode is activated when Steam ON button is pressed or Session Time has expired. Optional features such as Dimmer and Fan can be set at this state.

In the Standby Mode, steam room temperature will be maintained at a certain level (refer to standby temperature setting on page 7) Also water inside steam generator will be kept hot to give user fast steam when starting steam session.

## Current Day and Standby Time



This button displays the remaining standby time. You can change the standby time by pressing it. Use the up and down arrows to change settings.

The maximum standby time is set by dip switches in the steam generator. Refer to page 14.

## Pause Button



Short press the pause button to switch to On Mode. Long press it to switch to Off Mode. If autodrain is present, long press pause button to switch to Drain Mode.

# DRAIN MODE

Only applicable when autodrain is enabled by the Steam Generator DIP switches (refer to page 12) and in the Settings Menu (refer 3.5.4).



The autodrain feature automatically drains the water after every use. The tank is flushed and will remain empty until the steam generator is used again.

After the Standby Time expires, control unit automatically switch to Autodrain mode. During the drain cycle, the steam generator's tank is filled with cold water so that the valve can be opened safely.

The draining process will take about 10 minutes. You can press the OK button to cancel the draining.

# EASY MODE

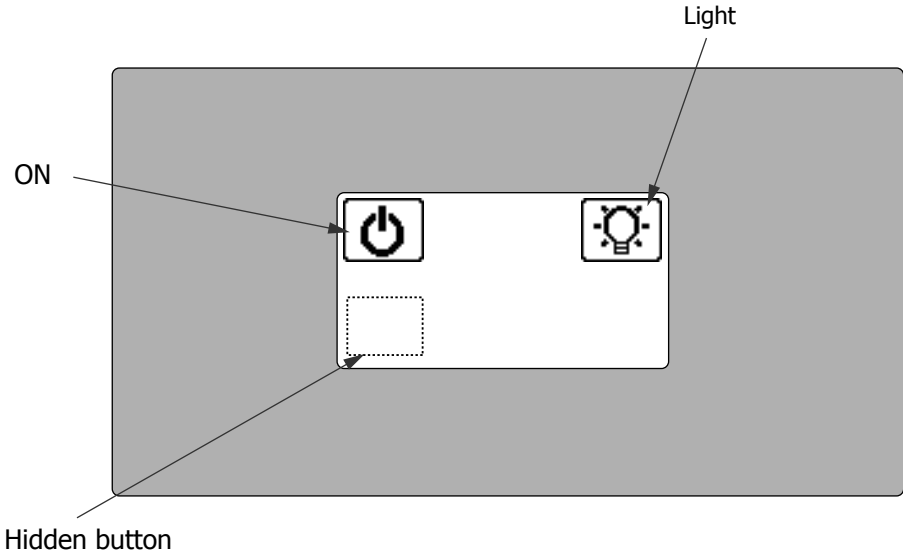

**See how to switch OFF Mode to Easy Mode. Refer to page 5.**

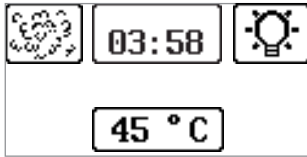

The Easy mode is a simplified ON State version. It displays the basic important functions of steam operation such as; Session Time, Temperature and Lights.

Press the session time, temperature and lights buttons to change their settings.

.....

## Hidden Button



Press the hidden button for 10 seconds to switch to Off Mode. Hidden button is active in Off and in Easy Mode.

.....

## Steam ON



Animated Steam ON button indicates that steam generation is ongoing. Short pressing this button will switch off the steam generator.

If autodrain is on, long press of the Steam ON button activates the Drain Mode. If autodrain is not present, long press of the Steam On button will switch off the steam generator.

# STEAM GENERATOR DIP SWITCHES

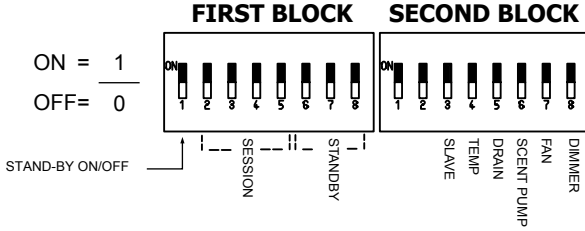
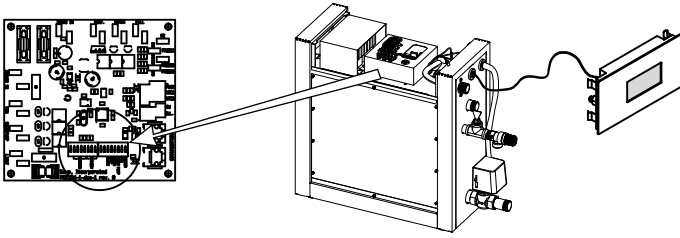

## Standby time

Standby time can be set according to user preferences by setting dip switches on the power controller board

Standby Duration Mode	Switch 6	Switch 7	Switch 8
4h	0	0	0
6h	0	0	1
12h	0	1	0
18h	0	1	1
Unlimited	1	0	0
4h	1	0	1
4h	1	1	0
4h	1	1	1

## First Block of 8 Switches

DIP No.	Function
8	Standby mode duration
7	Standby mode duration
6	Standby mode duration
5	Maximum session time
4	Maximum session time
3	Maximum session time
2	Maximum session time
1	Disable standby mode / Enable standby mode

## Dipswitches for other Functions

Dipswitch No.:	Function	On	Off
8	Cabin Light	Dimmer option enabled	Dimmer option disabled
7	Fan	Present	Not Present
6	Scent Pump	Present	Not Present
5	Auto Drain	Connected	Not Connected
4	Temperature range	30-55°C	30-50°C
3	Slave Unit	Yes	No
2	Slave Number		
1	Slave Number		

## Session Time

Session time can be set according to user preferences by session dip switches on the power controller board.

Session Time	Switch 2	Switch 3	Switch 4	Switch 5
10min	0	0	0	0
15min	0	0	0	1
20min	0	0	1	0
30min	0	0	1	1
45min	0	1	0	0
1h	0	1	0	1
2h	0	1	1	0
4h	0	1	1	1
6h	1	0	0	0
8h	1	0	0	1
12h	1	0	1	0
18h	1	0	1	1
Unlimited	1	1	0	0
10min	1	1	0	1
10min	1	1	1	0
10min	1	1	1	1

## Dipswitches for Naming Slaves

Slave No.	Switch 1	Switch 2
1	0	0
2	0	1
3	1	0
4	1	1

# CONTROL PANEL DIP SWITCHES

Back of Touch Control PCB

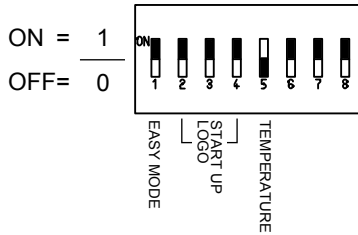
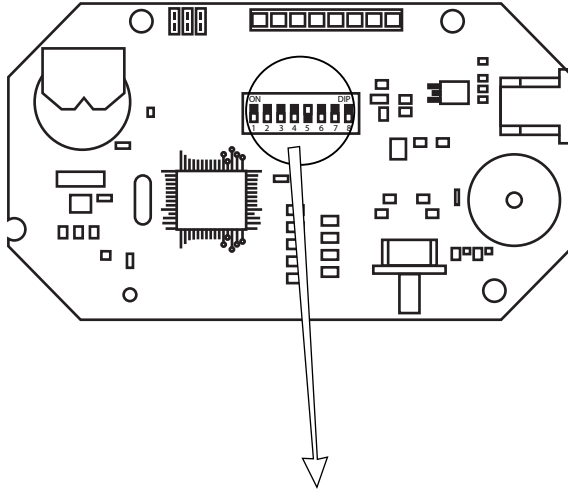

Dipswitch no.:	Function	On=1	Off=0 (Default)
8	-		
7	-		
6	-		
5	Temperature	Actual temperature will be shown in display	Set temperature will be shown in display
4	Start up logo		
3	Start up logo		
2	Start up logo		
1	Easy mode	UI is set to Easymode, Normal mode cannot be activated by user	Start default in normal mode. Easy mode can be activated by user.

Start up logo	SW2	SW3	SW4
No Logo	0	0	1
Sawo Logo	0	0	0

# REMOTE AND ALARM CONNECTIONS

(Back of the user's panel)

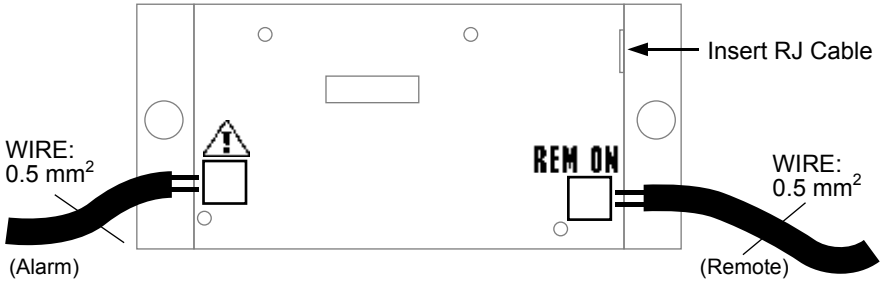

## Emergency Alarm



The steam generator control has a provision for emergency alarm system. Alarm button must have potential free momentary or latching contacts.

Long press OK button if alarm has been settled.

---

## Remote On

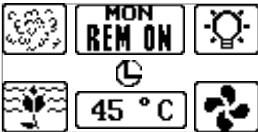

Used for automated households. The remote signal is a potential free contact. The steam generator switches on when contact is closed and remains on until contact is opened.

When the steam generator is remotely controlled, settings used from previous session are applied. Other buttons are locked. Only the Light, Fan and Aroma buttons can be set.



# MAINTENANCE

## Decalcification

Tap water contains impurities, for example lime, that can cause calcium deposit and block the internal parts of the steam generator. To prevent this and prolong the lifetime of steam generator it is recommended to have a water filter and water softener. They are connected to the water source of the steam generator's water inlet.

SAWO Decalcifying Solution can be used for decalcification. Follow these guidelines to perform preventative maintenance of the steam generator.



### WARNING!

Never add the Decalcifying Solution when the generator is on, it can cause serious burns!

### Stainless Steel Touch Control:

1. Turn ON the steam generator.
2. Go to Settings menu by pressing three seconds the settings icon. Scroll to the "Decalcifying" menu and press "Start". Confirm by pressing "OK".
3. Next process shows that water is filled in the tank. After water is filled, add decalcifying solution: Remove the cap of tee pipe in the over pressure valve piping. Pour the decalcifying solution into the tank. Return back the cap to its original position when done.
4. After pouring the solution, press "OK" on the screen. Steam generator will automatically go through decalcifying process including draining. After process is done, screen will go to off state. Fill and drain the tank with water two times more by switching ON and draining the steam generator.

Use Decalcifying Solution as follows:

Steam Generator (kW)	Decalcifying Solution (ml)
3-7,5	250
9-15	500

For steam generators in commercial use (over 5 hours continuously daily) additional service plan is recommended twice a year. Please contact your service center for details.

### Frequency for decalcification:

Unit dH where 1 dH is 10 mg calcium in 1 liter of water

- < 3 °dH = very soft water, decalcification every 500 operation hours
- 3-6 °dH = soft water, decalcification every 100 operation hours
- 6-9 °dH = hard water, decalcification every 50 operation hours
- 9-18 °dH = very hard water, decalcification every 30 operation hours

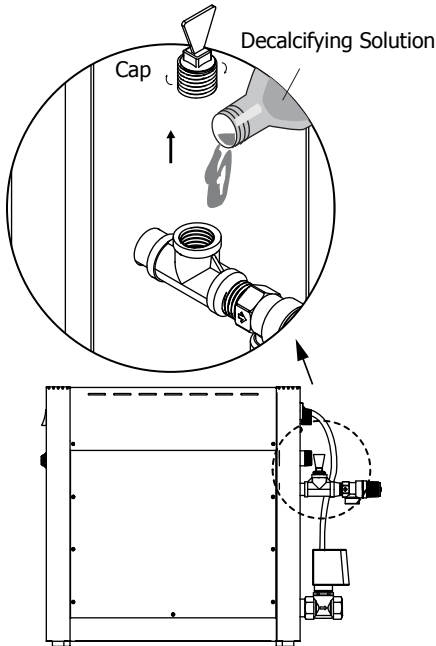

# TROUBLESHOOTING

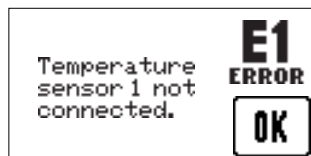

If an error occurs the steam generator will automatically switch off. A warning beep will alarm the user every 2 seconds. The error code will be displayed blinking in the control panel, see the table below.

Please note, only a qualified electrician or maintenance personnel are allowed to make service operations and repairs! Long press OK button to switch OFF Mode.

## For Tandem Connection:

If an error occurs in one of the slave units, error message is followed by slave number. For example: E1 -> S2 -> E1 ->S2... Pressing the ON/OFF button disables the slave and rest of the generators can operate normally.

See steam generator manual for tandem connection.

## Error codes:

Code	Problem	Solution
E1	Temperature sensor 1 not connected.	Check the wire between the sensor and the control unit.
E2	Temperature sensor 1 short circuit.	If there is no problem with the wires and they are correctly installed, check the sensor.
E3	Temperature sensor 2 not connected.	
E4	Temperature sensor 2 short circuit.	If no problem can be found, contact the retailer.
E5	Temperature fuse defect.	
		Check the wire between the fuse and the control unit. Fuse has probably overheated. The reason for it needs to be discovered before using the steam generator again. A new fuse is needed.  If no problem can be found, contact the retailer.

Code	Problem	Solution
E6	Water level too high and operation not permitted.	Check that the drain valve is not blocked. Clean the level probes. If no problem can be found, contact the retailer.
E7	Water level too low and operation not permitted.	Check that water supply is open and there is enough pressure. Check solenoid valve. Clean level probes. If no problem can be found, contact the retailer.
E8	Illogical combination of water level measurements.	Clean level probes. If no problem can be found, contact the retailer.
E9	Fill failure.	Check that water supply is open and there is enough pressure. Check solenoid valve. Clean level probes. If no problem can be found, contact the retailer.
E10	Drain failure.	Check that the drain valve is connected and not blocked. Clean the level probes. If no problem can be found, contact the retailer.
E11	Communication failure.	Check the RJ12 cable. If the area where cable is located has many other cables, it can cause EMC problems. If no problem can be found, contact the retailer.
E12	Temperature is greater than the maximum temperature.	Contact qualified electrician or maintenance personnel before using the steam generator again.
E13	No master steam generator connected.	Dip switch setting is incorrect. Check dip switch settings. Check RJ12 for loose contact. Replace RJ12. If no problem can be found, contact the retailer.

CE IPX4  T40  EAC

Subject to change without notice.



[www.sawo.com](http://www.sawo.com) | [info@sawo.com](mailto:info@sawo.com)

STN\_SST\_ML\_(En0119)